

Cabinet Assembly Instructions

UFO 550

Aqua One



Contents:



Ax10



Bx10



Cx10



Dx8



Ex1



Fx8



Gx8

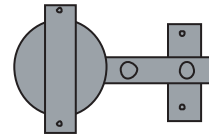

Hx2



Ix4

Tools required:

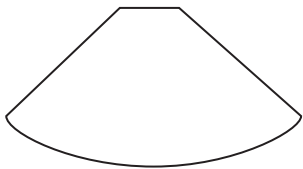

L(a)

Top
(View
from
above)

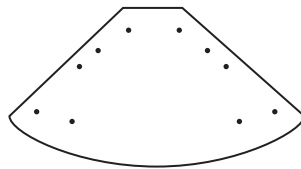

M(a)

Base
(View
from
above)

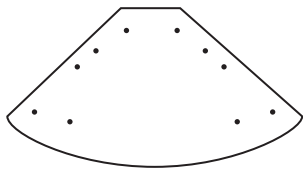

L(b)

Top
(View
from
below)

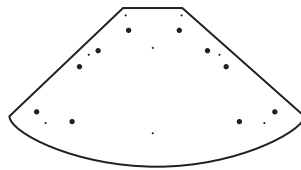

M(b)

Base
(View
from
below)

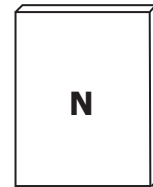

N

Shelf x 1

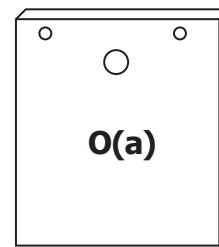

O(a)

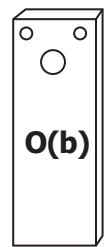

O(b)

Back panels

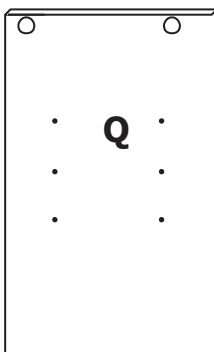

Q

Left side

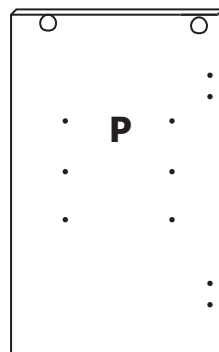

P

Right side

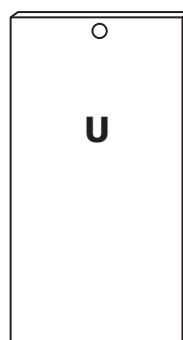

U

Outer Panels
x 2

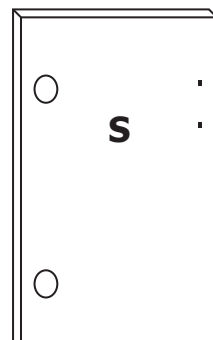

S

Right door

Step 1: Install the locking nuts, screws and door hinges.

Use panels L(b), O, P, Q, U x 2, S. Use parts A x 10, B x 10, H x 2, F x 4, E x 1.

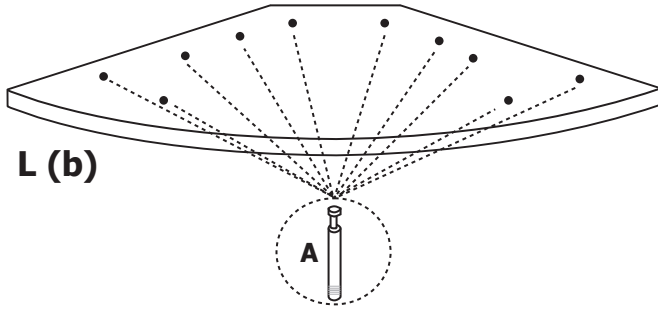

L (b)

A

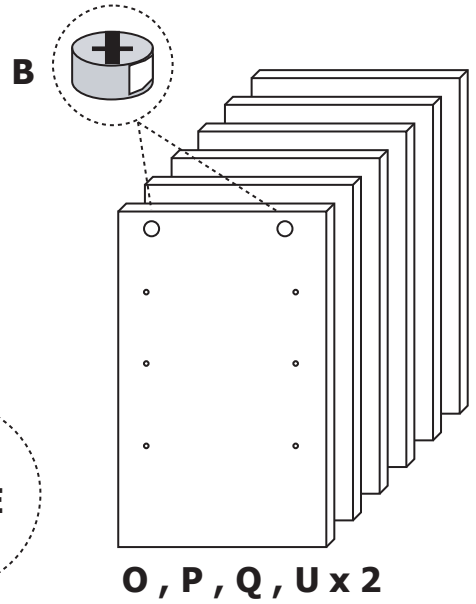

B

O, P, Q, U x 2

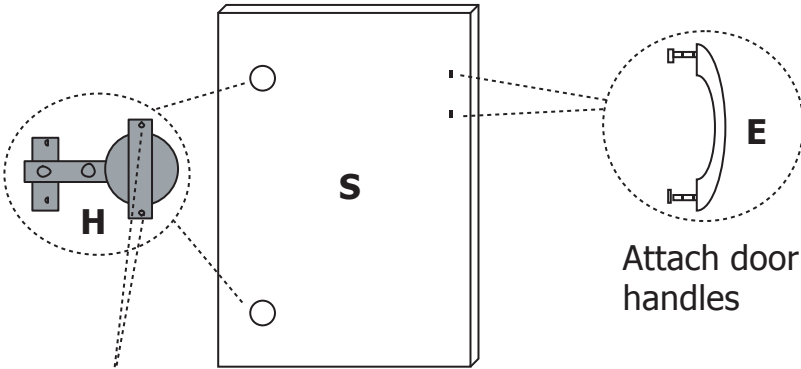

H

S

E

Attach door handles



F

Fasten hinges (H) to door panels using screws (F)

Step 2: Install the side and outer panels to the top L(b). Use panels P, Q, U x 2.

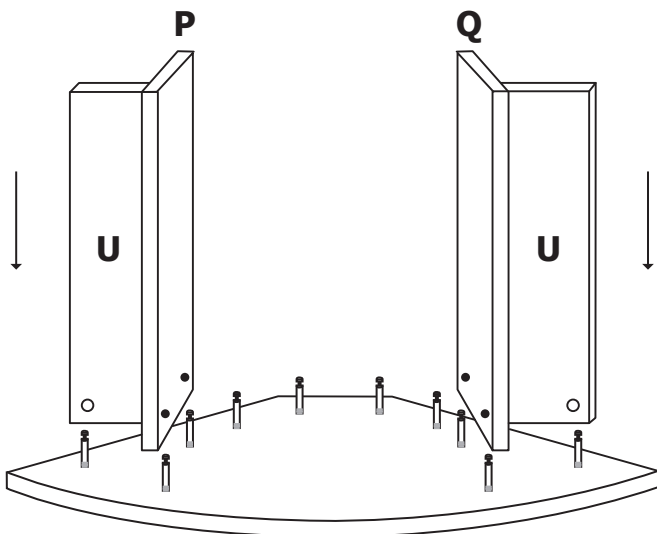

L (b)

Step 3: Install the back panels to the top. Use panels O(b), O(a).

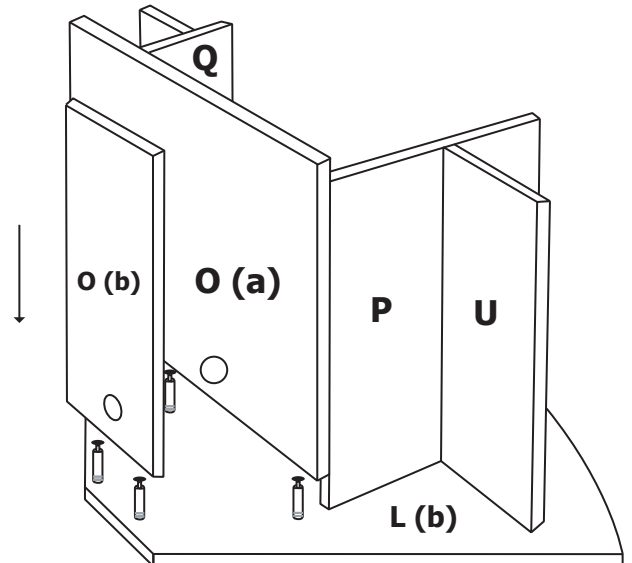

L (b)

Step 4: Attach base M(b) and install feet.
Use panel M(b). Use parts C x 10, G x 8, D x 8.

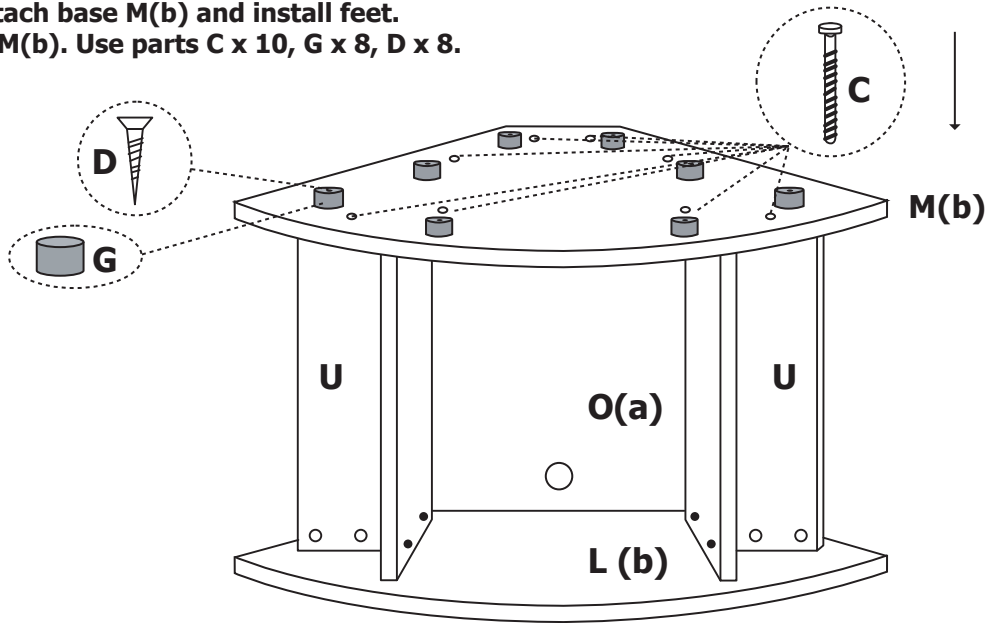

Then turn the cabinet over on its feet



Step 5: Install the shelves,
Use panels N x 1. Use parts I x 4.

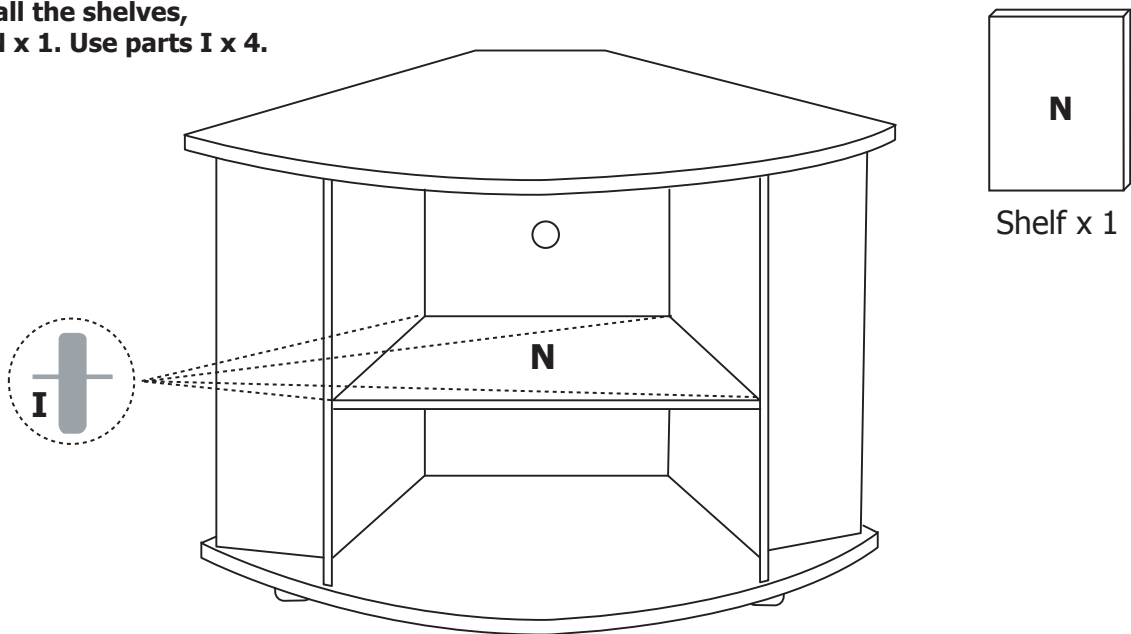

Step 6: Attach door S to cabinet using screws F into the predrilled holes.
Use parts F x 4.

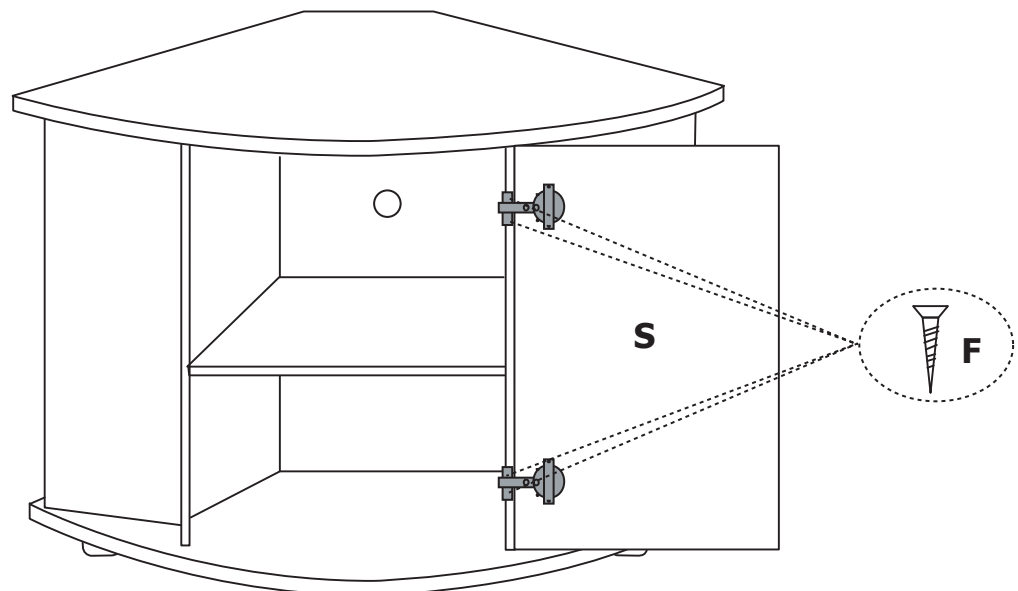

Your cabinet is now complete.

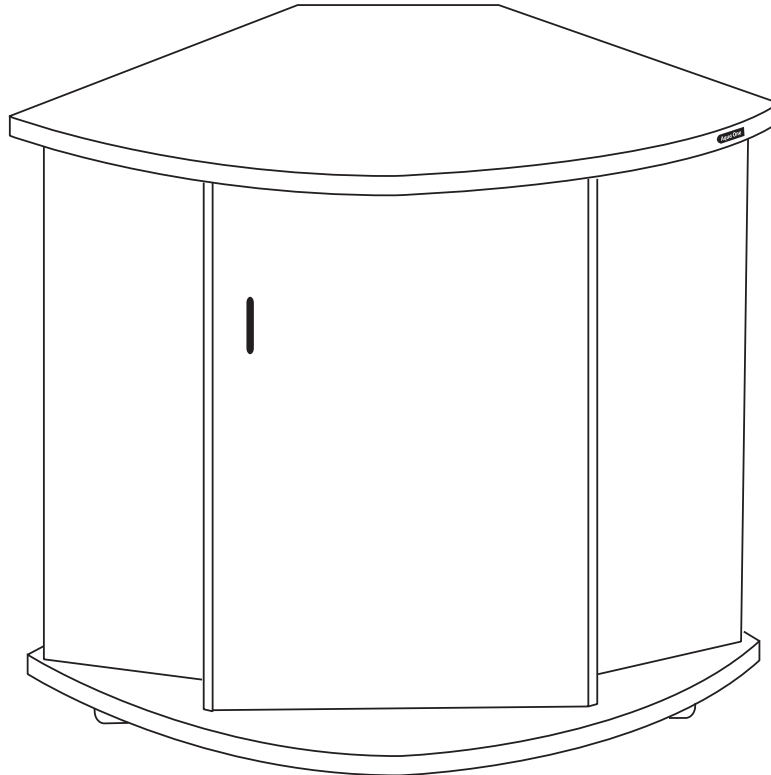

Important Notice

It is absolutely imperative that you ensure this cabinet and aquarium is installed upon level flooring. It is also a prerequisite that you ensure the flooring upon which it is positioned is able to support the weight of this aquarium which could be up to **600kg** including water and decorations.

Installation upon uneven flooring will result in poor distribution of weight. Damages to the aquarium, cabinet or equipment and damages caused by leaks due to improper or uneven installation are not covered by the guarantee with this product.

Care and Maintenance of your Aqua One Aquarium

Glass: It is recommended that you use a good quality glass cleaner and a non abrasive lint free cloth. Glass cleaner should only be used on the outside of the aquarium.

To clean the glass on the inside of the aquarium, it is recommended that you use an Aqua One Scraper or Magnetic Cleaner (available from your local Aqua One dealer).

Cabinet and Hood: The use of a damp cloth is recommended, do not use any detergents or harsh chemicals to clean the cabinet and hood as damage may occur.

Precision Manufactured in the P.R.C.
Designed in Australia by Aqua One
Distributed in Australia by:
Kong's (Aust.) Pty. Limited
48 Williamson Rd. Ingleburn.
2565 NSW Australia.

Distributed in New Zealand by:
Kong's (NZ) Limited
52 Glenlyon Avenue.
Greerton. Tauranga New Zealand.

Distributed in the UK by:
Kong's (UK) Ltd.
C/O Aqua Pacific UK Ltd.
PO Box 268
Romsey Hampshire
S051 0WW
United Kingdom

® Aqua One and Kong's are registered trademarks. www.aquaone.com.au. © Aqua One 2005