



Aqua One[®]

Inspiring Excellence in Fish Care!

AquaLantern 300



Instruction version: 03/02/2014

www.aquaone.com.au

Important Safeguards

To guard against injury, basic safety precautions should be observed, including the following:

1. Read and follow all safety instructions and important notices in these instructions as well as on the product itself.

2. This appliance is not intended for use by children or infirm persons without supervision. Young children should be supervised to ensure that they do not play with the appliance.

3. To avoid possible electric shocks, special care should be taken since water is employed in the use of aquarium equipment. For each of the following situations do not attempt repairs yourself. Return the appliance to an authorised service facility for service or discard the appliance.

a. If the appliance or any electrical component of the appliance (non-immersible equipment only) falls into the water or gets wet, do not reach for it. Unplug it and then retrieve it.

b. If the appliance shows any sign of abnormal water leakage, immediately unplug it from the power source.

c. Carefully examine the appliance after installation. It should not be plugged in if there is water on parts which are not intended to be wet.

d. Do not operate the appliance if it has a damaged cord or plug, or if it is malfunctioning, or dropped or damaged in any manner.

4. A "drip loop" (see graphic) should be arranged for each cable connecting an aquarium to a power supply. The drip loop is the part of the cable below the level of the power supply. It prevents water travelling down the cable and coming into contact with the power supply. If the plug or the socket does get wet, do not unplug the appliance. Disconnect the fuse or circuit breaker that supplies the power to the appliance, then unplug and examine for presence of water in the socket.

5. Always unplug the appliance from the electrical outlet when not in use, before putting on or taking off parts, before any type of maintenance or cleaning.

6. Never yank the cable to pull it from the socket. Pull the plug carefully to disconnect.

7. Do not use the appliance for reasons other than the intended use. The use of attachments that are not

recommended or sold by the manufacturer may cause the product to be unsafe. This is not recommended.

8. Do not install or store the appliance where it will be exposed to weather or temperatures below freezing.

9. Make sure any component mounted on a tank is securely installed before operating it.

10. Ensure input voltage is the same voltage as your local power supply.

11. If an extension cable is used it should have the proper rating. Care should be taken to arrange the cord so that it will not be tripped or pulled.

12. A G.F.C.I (Ground fault circuit interrupter) & surge protector is recommended for all electrical appliances.

13. Ensure your hands are dry when turning the power switch on/off and when inserting/removing the power cable from the socket.

14. If you are in any doubt about the electrical installation or safety of this product you must consult a qualified electrician.

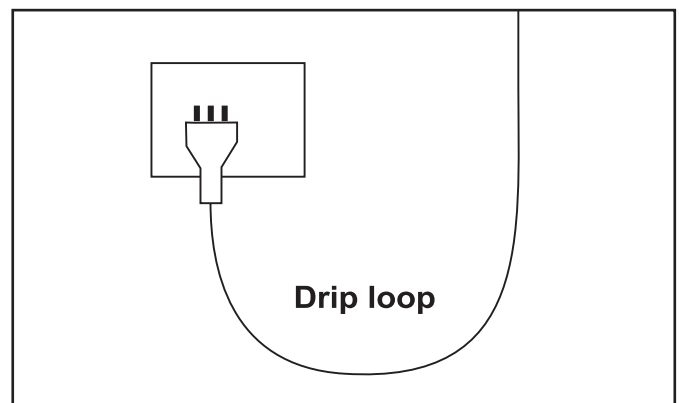

For Guarantee Conditions, please refer to the Guarantee form that is enclosed with this product.

All products are supplied with fitted plugs. This plug should not be tampered with in any way or removed. Removal or tampering with the plug invalidates our guarantee offered with this product.

For UK a 3 pin adaptor is supplied with the product and this must be used.

Overview

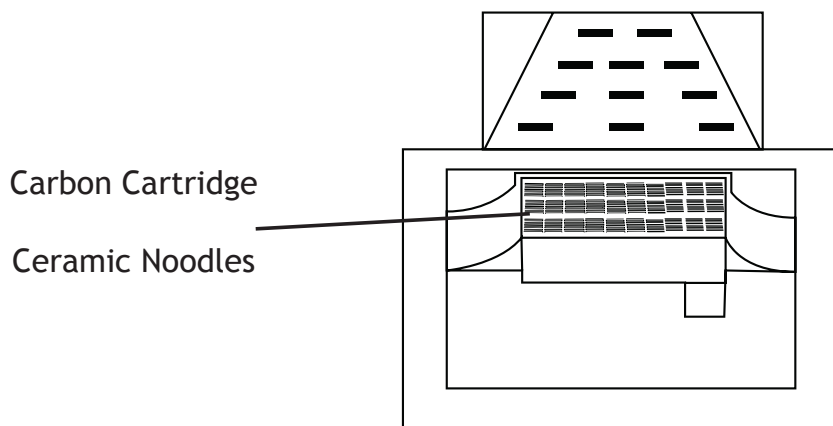
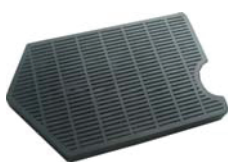
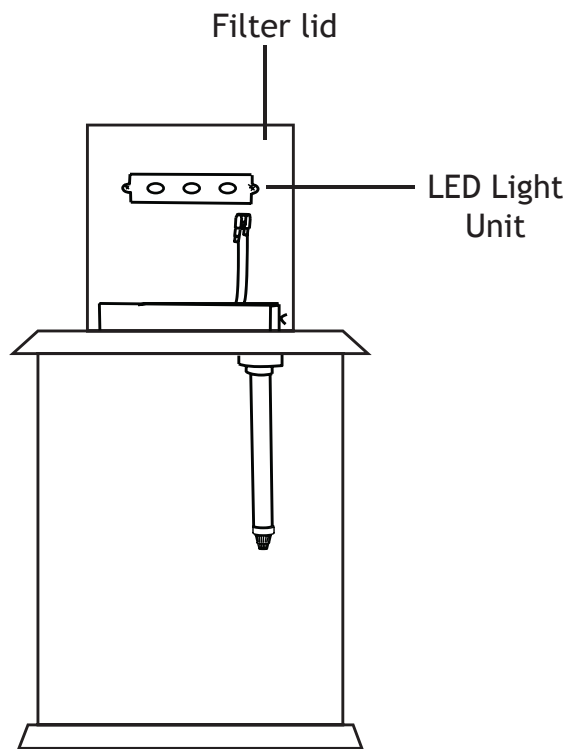
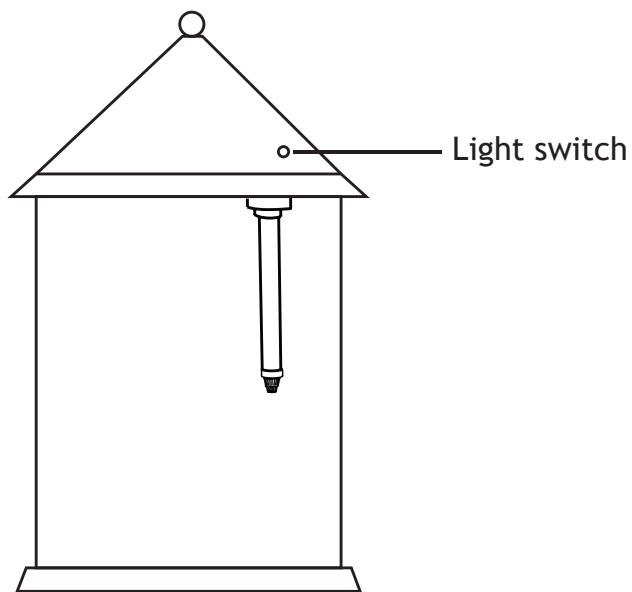
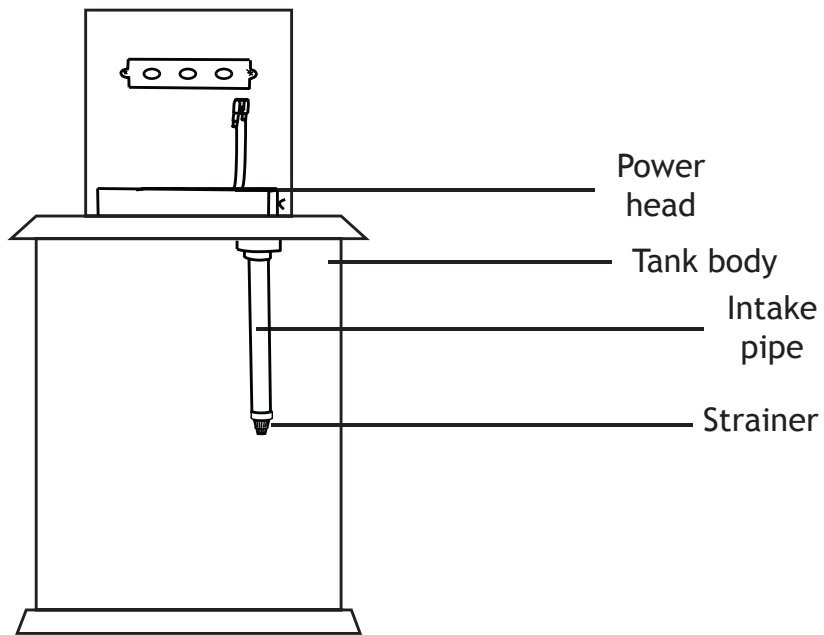

Before First Use/Preparation

Setup Instructions

Read and follow all the instructions, even if you feel you are familiar with the product and find a place to keep the instructions handy for future reference. Your attention is drawn particularly to the sections concerning **"IMPORTANT SAFEGUARDS"** and the **"GUARANTEE CONDITIONS"**. Please ensure you retain your original purchase receipt in the event that guarantee service is required.

Carefully unpack the aquarium making sure you keep all the packing material until all the parts of the product have been found and the product has been assembled.

This product is shipped to you in a factory sealed carton. Should the product malfunction in any way or if the unit is damaged and requires replacement, contact the retailer where the product was purchased for inspection.

Replacement Parts & Filter Media

Use Aqua One Genuine Spare Parts Only. See your local Aqua One Dealer and look for the spare part you require. Alternatively you will find these numbers on the silver label located on the product.

Impeller	1071
Carbon Cartridge	143C

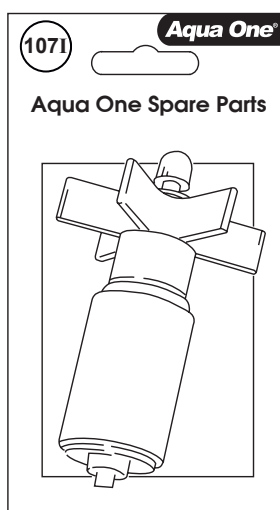

1. Select the location for your aquarium. Avoid direct sunlight and areas where temperatures fluctuate greatly such as in front of heaters and air conditioners.

2. Place the aquarium on a flat, level surface. We recommend the use of an Aqua One aquarium cabinet.

3. Lift the filter lid of the aquarium, this will allow access to all parts of the aquarium including the light and filter.

4. The filter comes assembled and no setup is required. However, check all pipes are connected securely and the filter media is in the correct position as per the diagrams on the previous page.

5. Wash aquarium gravel. Place a portion of gravel in a bucket, run water through and churn the gravel until the water running out of the bucket is clear. Repeat this until all the gravel is washed.

6. Place the gravel into the bottom of the aquarium.

7. Place any rocks, ornaments or plants into the aquarium.

8. If the aquarium is to be used for tropical fish, place the heater in the aquarium. Follow the instructions provided with the heater to set up and install the heater.

9. Fill the aquarium with water. The water level should be below the plastic frame on the inside of the aquarium but high enough that the water level is not visible when the aquarium is running.

10. Add water conditioner to the water, follow the directions on the label.

11. Close the filter lid.

12. Ensure your hands are dry and plug the power cords into a power outlet. Drip loops as described in the important safeguards section of this instruction booklet must be used.

13. Once the unit is turned on at the power outlet the filter should automatically start

14. To switch on the light unit use the switch located on top of the filter lid.

Tips

It is recommended that for freshwater aquariums, the filter is run for at least 5-7 days before fish are added. This allows the filter to cycle and establish a population of beneficial bacteria which break down waste in the aquarium water.

Check the water parameters such as pH and kH. If you are unsure what the levels should be for your fish, seek advice from your aquarium retailer.

Allow at least a week between fish additions. This allows the biological filter to adjust to cope with the additional waste.

Remember, all fish will grow. When selecting fish, make judgements based on the maximum size the fish will grow, not simply based on the size the fish is at the store.

Consult your local aquarium retailer for advice on stocking your aquarium.

Maintenance

AQUARIUM MAINTENANCE

DAILY:

While feeding your fish, check that all equipment is operating correctly. Check that the filter is running and the strainer is not blocked. If a heater is being used, check the temperature of the aquarium and ensure the heater is functioning.

FORTNIGHTLY: 25% Water change

What you will need: A bucket, towel, gravel vacuum and water conditioner.

1. Ensure your hands are dry.
2. Switch off light unit and unplug power cable to turn off filter.
3. Lift the filter lid in order to access both the aquarium and the filter.
4. Place the towel on the floor in front of the aquarium in case of water spillage.
5. Use an algae scraper to clean the glass.
6. Using the gravel cleaner, remove approximately 25% of the water from the aquarium. Discard the water. The water can be used to water your garden as the nutrients will be beneficial to plants and this prevents water from being wasted.
7. Fill the bucket with new water, add water

conditioner as per the instructions on the bottle.

8. Add the conditioned water to the aquarium. Repeat this until the aquarium is filled to the water level outlined on the previous page.
9. Close the filter hood of the aquarium.
10. Check for any water spillage on or around the aquarium and wipe with the towel.
11. Plug the power cable in at the power outlet and switch it on. Switch the light back on also.

FILTER MAINTENANCE

MONTHLY:

NOTE: the carbon cartridge should be replaced every 4-6 weeks. Spare cartridges are available from your local aquarium retailer.

1. Ensure your hands are dry.
2. Switch off light unit and unplug power cable to turn off filter.
3. Lift the filter lid in order to access both the aquarium and the filter.
4. Place the towel on the floor in front of the aquarium in case of water spillage.
5. Disconnect the intake pipe and strainer from the power head. Clean these parts with a pipe cleaner and rinse under tap water.
6. Remove the power head from the filter. In order to do this, simply push the power head downwards.
7. Pull the impeller cover off in order to access the impeller. (see next page for diagram)
8. Grasp the impeller blades and remove the impeller from the power head.
9. Clean the impeller chamber with a pipe cleaner.
10. Reassemble the power head. Ensure the grommets are in place on both ends of the shaft. Missing grommets can cause the pump to be noisy as well as causing low flow and extra wear on the power head.
11. Reassemble the filter and ensure the filter is securely connected to intake pipe.
12. Ensure the power cables are not wet. Plug the power cables at the power outlet and switch on. Switch the light back on also.

Maintenance

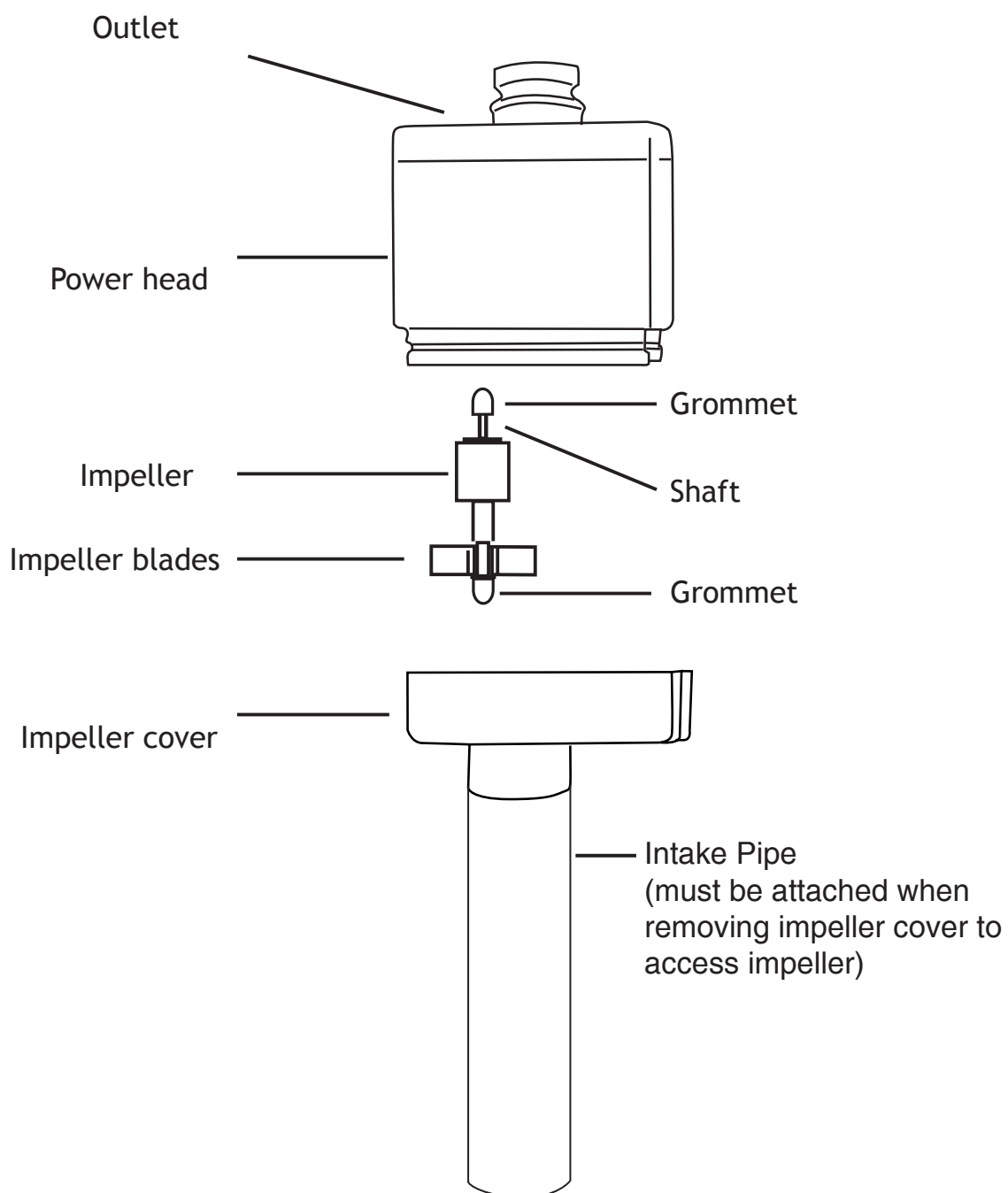
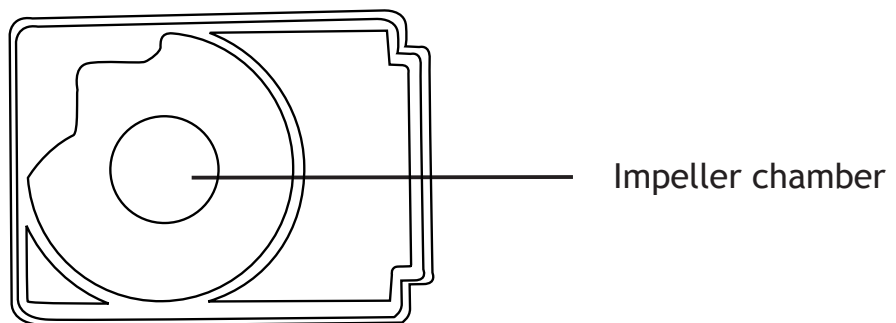

Troubleshooting

If you are in any doubt about the electrical installation or safety of this product you must consult a qualified electrician.

LIGHT UNIT DOES NOT WORK

1. Ensure switch is in the on position on the top of the light unit.
2. Check if its is plugged into the power supply and the switch is on.

POWER HEAD WORKING BUT NO / SLOW WATER FLOW

1. Check impeller is in good condition and replace if needed.
2. Make sure water level in aquarium is above the power head. Please note the power head is a water proof unit.
3. Clean impeller, power head and all inlet and outlet pipes.
4. Check power head is assembled correctly, check that both grommets are in place at the ends of the shaft.

AQUARIUM POSSIBLY LEAKING

1. Replace carbon cartridge is blocked and dirty as this can create an overflow.
2. Make sure water level is not to high. Refer to setup instructions.
3. If an air stone is being used check it is not bubbling water over the rim of the aquarium if so turn the air pump down.
4. Make sure the aquarium is sitting on a level surface.
- 5a. Remove the filter unit from the top of the aquarium. Mark the water level. Remove any excess water that may be sitting on the edge of the aquarium. Leave for an hour. If water level drops proceed to step 5b.

5b. Remove the fish, decorations and gravel. Empty the aquarium and clean the glass DO NOT WASH IN SOAP OR DETERGENT. Place a piece of newspaper on a flat level solid surface. Carefully fill the aquarium ensuring not to spill any water on to the newspaper. Leave the aquarium for several hours and then inspect the newspaper for wet patches.

Specifications

Aquarium Model: AquaLantern
Dimensions: 28 x 28 x 40cm
Aquarium Volume: 20L
Filter Flow Rate: 150L/Hr
Light Wattage: 2.5W LED
Input: 110-240V / AC
Output: 9V / DC 1500mA
Suitable: Coldwater, Tropical

Disposal of used Electrical & Electronic Equipment (Applicable in the European Union and other European countries with separate collection systems)

This symbol on the product or on its packaging indicates that the product must not be disposed of with normal household waste. Instead, it is your responsibility to dispose of your waste equipment by arranging to return it to a designated collection point



for the recycling of waste electrical and electronic equipment. By separating and recycling your waste equipment at the time of disposal you will help to conserve natural resources and ensure that the equipment is recycled in a manner that protects human health and the environment. For more information about recycling this product, please contact your local city office, your household waste disposal service or the shop where you have purchased the product.

Aqua One - Guarantee 1 + 1 Year

The additional 1 Year **Extended Guarantee** applies when you **REGISTER online** with Aqua One. Register your Extended Guarantee at www.aquaone.com.au

The Aqua One Aquarium purchased must be installed upon a level surface and weight bearing cabinet and there upon level and load bearing flooring (using a level is recommended). The purchaser must consider the total weight of all items when installing an Aquarium which could be up to 1200kg dependant on the model and accessory items chosen. Consider this, 1L of water = 1kg weight.

About this Guarantee

The Manufacturer or Distributor, of Aqua One goods, is collectively known herein as "Aqua One". Please refer to contact details for Aqua One below or on the applicable Aqua One website. Any product that is covered by its own Guarantee (as enclosed with the product) is subject to the conditions of that Guarantee.

The benefits given to the purchaser, under Guarantee, are in addition to all other statutory rights and remedies which the purchaser has in respect of goods under legislation in the applicable country of purchase. This Guarantee shall not affect any such rights and should be read subject to such legislation.

1.0. Terms and Conditions of Guarantee.

- 1.1. Aqua One warrants to the purchaser, for 1 Year from date of original purchase, to repair or replace goods where fault is found due to defective materials or faulty workmanship and where goods do not operate in accordance with the instructions.
- 1.2. All claims for repair or replacement must be made at place of purchase.
- 1.3. The original and dated Proof of Purchase (receipt) must be supplied with all goods claims. Please also provide this Guarantee where possible.
- 1.4. The Guarantee covers the Aquarium against gluing breakdown resulting in leakage.
- 1.5. All goods subject to claim under Guarantee should be prepared for transportation in the original packaging or other comparable packaging which offers the same degree of protection.
- 1.6. Where goods are repaired or replaced under Guarantee, these goods are Guaranteed for the remainder of either the original Guarantee or Extended Guarantee period.
- 1.7. Where claims on inspection reveal goods are in normal working order, Aqua One will request reimbursement of all reasonable costs incurred.

2.0. Other Terms and Conditions – Extended Guarantee

- 2.1. The Extended Guarantee period is for an additional 1 Year and commences on expiration of the standard guarantee period.
- 2.2. Application for Extended Guarantee is FREE of any registration cost to the purchaser on completion of the Extended Guarantee questionnaire which is found on the applicable Aqua One website (refer below).
- 2.3. Upon receipt and acceptance of the questionnaire, Aqua One will forward (by way of email) a Certificate of Extended Guarantee to the purchaser.
- 2.4. For more information on how we collect, hold, use and disclose personal information provided to us, please refer to our Privacy Statement on the Aqua One websites or write to our Privacy Officer, in your country of purchase.
- 2.5. Where Aqua One determines goods are being used in a manner contrary to the instructions, specifications or this Guarantee, Aqua One reserves the right to terminate Extended Guarantee for such goods and will provide written notice to the purchaser.

3.0. Exclusions and Limitations

Where permitted by local law, the following exclusions and limitations apply in regard to Guarantee:

- 3.1. Glass breakage, for whatever reason caused after Aquarium purchase.
 - 3.2. Goods claims where fault is due to, but not limited by a) misuse b) neglect c) abuse d) fire or flood e) normal wear and tear f) accidental breakage g) Acts of God h) mains voltage fluctuation or supply problems i) connection to any voltage other than what is stated on the rating plate j) modification or tampering to electrical cord or plug, k) vermin, insects or foreign object l) liquid spillage or submersion of goods not designed to sustain such use or duress.
 - 3.3. Where inspections reveal goods are in normal working order including where noise or vibration is consistent with normal goods operation.
 - 3.4. Attempted repairs or modifications by unauthorised persons, including but not limited to the drilling of holes in the aquarium glass by unauthorised persons.
 - 3.5. Where the goods factory rating plate has been removed, altered, damaged or is rendered illegible.
 - 3.6. Where goods are not installed, operated or maintained in accordance with Aqua One's goods instructions, specifications or this Guarantee.
 - 3.7. Replacement or repair of worn consumables or replacement of lost goods, parts or components.
 - 3.8. Costs associated with goods transportation, removal, installation, postage or cost of insurance.
 - 3.9. Any damage incurred whilst installing, transporting or moving the goods.
 - 3.10. Subject to certain local statutory rights and obligations to the contrary, and this guarantee shall not affect those rights or obligations, where, to the full extent permitted by law: 1. all express and implied warranties and conditions under statute or general law, are expressly excluded and Aqua One, where permitted, will limit liability as follows and at Aqua One's option to: in regard to goods either a) the replacement of goods or supply of equivalent goods b) the repair of goods or the cost of replacing the goods or of acquiring equivalent goods OR in regard to services either c) the re-supply of services d) the cost to re-supply services.
2. Aqua One will not be liable for any loss or damage, including consequential loss or damage either directly or indirectly, or for any incidental expenses, of any kind, and in any way whatsoever.

(1) we recommend the use of an Aqua One Cabinet (sold separately) as specially designed to suit the Aqua One Aquarium purchased.

(2) consider total weight of all items such as: Aquarium, cabinet, water, filtration, gravel/substrate, decorations and other equipment.

(3) consumables include items such as filter media/cartridges, impellers and shafts, light tubes, lamps, bulbs and starters.

(4) due to the extremely fragile nature of glass and glass being the main component of an Aqua One Aquarium, we strongly recommend that you advise your insurer and consider adding this item to your policy.

(5) When moving the Aquarium from its original or subsequent set-up location/s the following should be adhered to prior to moving the aquarium: remove all aquatic fish, animals or plants, filtration, gravel/substrate, decorations, other equipment mounted on or in the aquarium and ALL water. Also separate the Aquarium from the Aquarium cabinet or similar household item.

Aqua One may be contacted in:

Australia
Kong's (Aust.) Pty. Limited
PO Box 863, Ingleburn
1890 NSW Australia
www.aquaone.com.au

Hong Kong
Kong's Aquarium Supplies Co., Ltd
No 31, 3/F Thriving Industrial Centre
26-38 Sha Tsui Road, Tsuen Wan,
Hong Kong
www.aquaone.co.hk

New Zealand
Kong's (NZ) Limited
PO Box 15 - 183, Tauranga
3015 New Zealand
www.aquaone.co.nz

United Kingdom
Kong's (UK) Limited,
C/O Aqua Pacific UK Ltd.
PO Box 268
Romsey Hampshire, SO51 0WW
United Kingdom
www.aquaone.co.uk

This Aquarium is designed to help simplify general fish keeping. Please note, some specialist fish and aquatic animal or plant keeping require certain considerations, prior to purchase, to ensure proper and successful Aquarium keeping. Therefore, **Aqua One recommends, at time of Aquarium purchase, that you consult with your Aqua One Retailer in regard to the suitability of this product for the types of fishes, aquatic animals or plants you may wish to keep.** Special consideration should also be made in regard to filtration, aquarium heater and lighting requirements to ensure they are specific to your application.

Aqua One[®]

www.aquaone.com.au

® Aqua One is a registered trademark.